

Duck Headpiece

Fun things to do: page 1 of 4

What you need

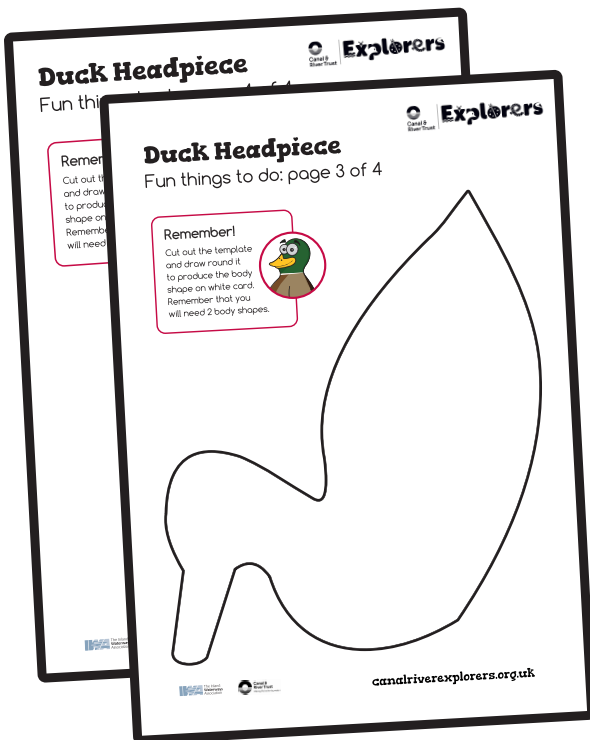

Duck headpiece template sheets

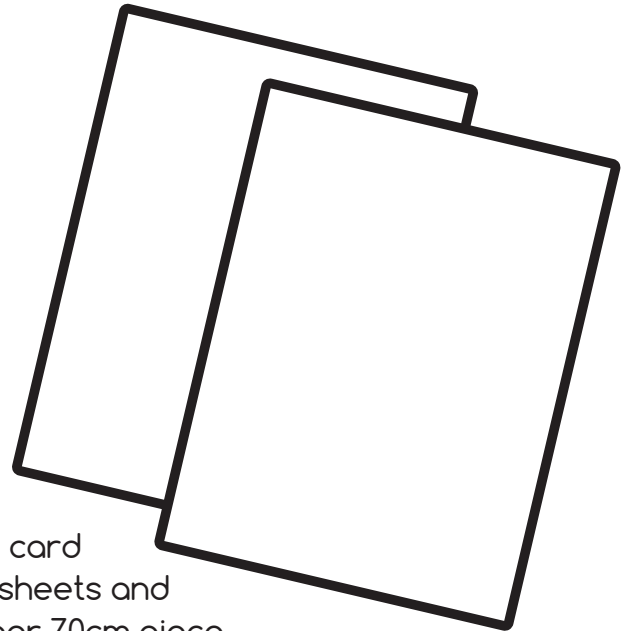

White card
(3 A4 sheets and
a longer 70cm piece
for the headband)

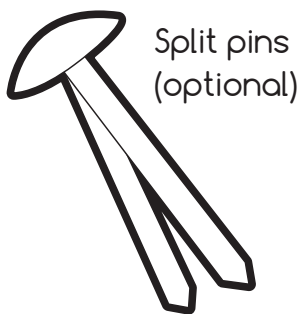

Split pins
(optional)

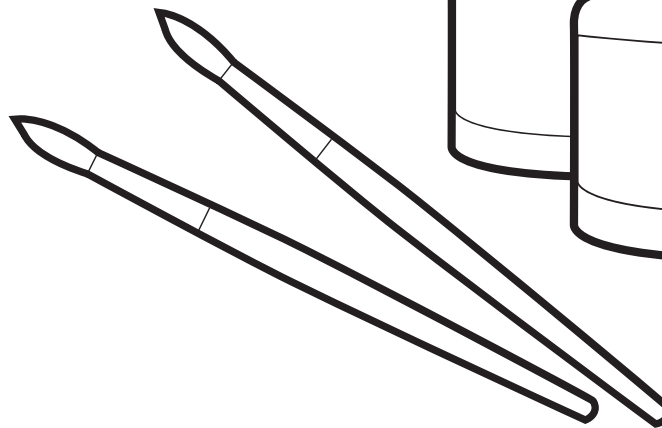

Paint & paint
brushes

Top Tips

When you staple the headband, make sure that the ends of the staple are on the **OUTSIDE** of the headband to avoid scratching. You could use real feathers to decorate the duck.



Duck Headpiece

Fun things to do: page 2 of 4

Cut out the shapes on the template sheets. Draw round them on white card to produce 2 sets of 2 shapes. Cut out and turn one set over so one set mirrors the other.

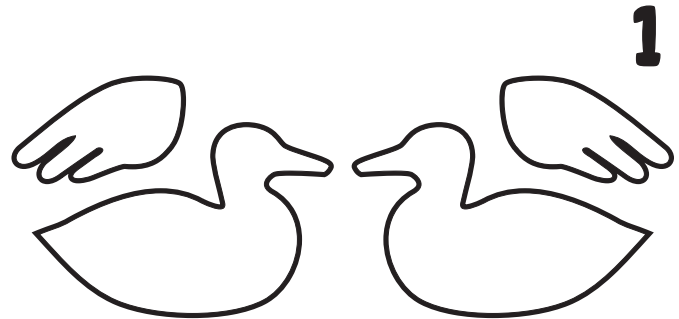

Decorate the two ducks (make sure that the two ducks are coloured on the right side, so you have 2 ducks 'facing' each other).

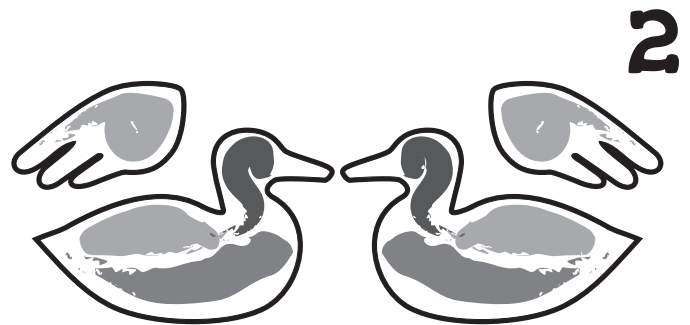

Attach each wing to its body using either staples or a split pin. Try to find a dry part of the wing to fasten.

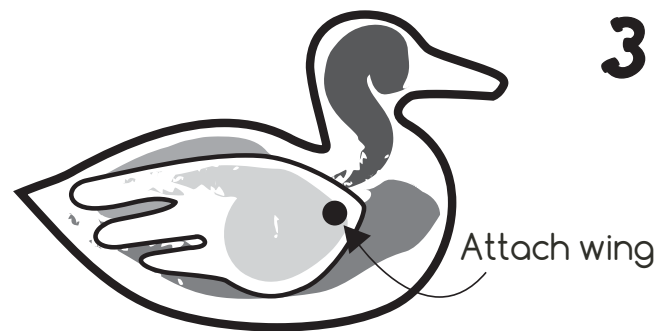

Ask an adult to fit the headband round your head and staple into a circle. Staple the ducks to each side of the headband.

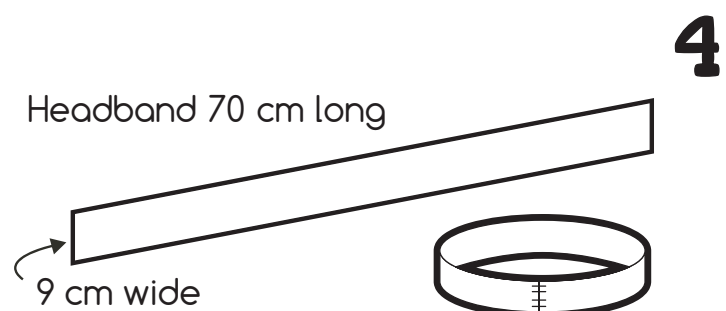

Duck Headpiece

Fun things to do: page 3 of 4

Remember!

Cut out the template and draw round it to produce the body shape on white card. Remember that you will need 2 body shapes.

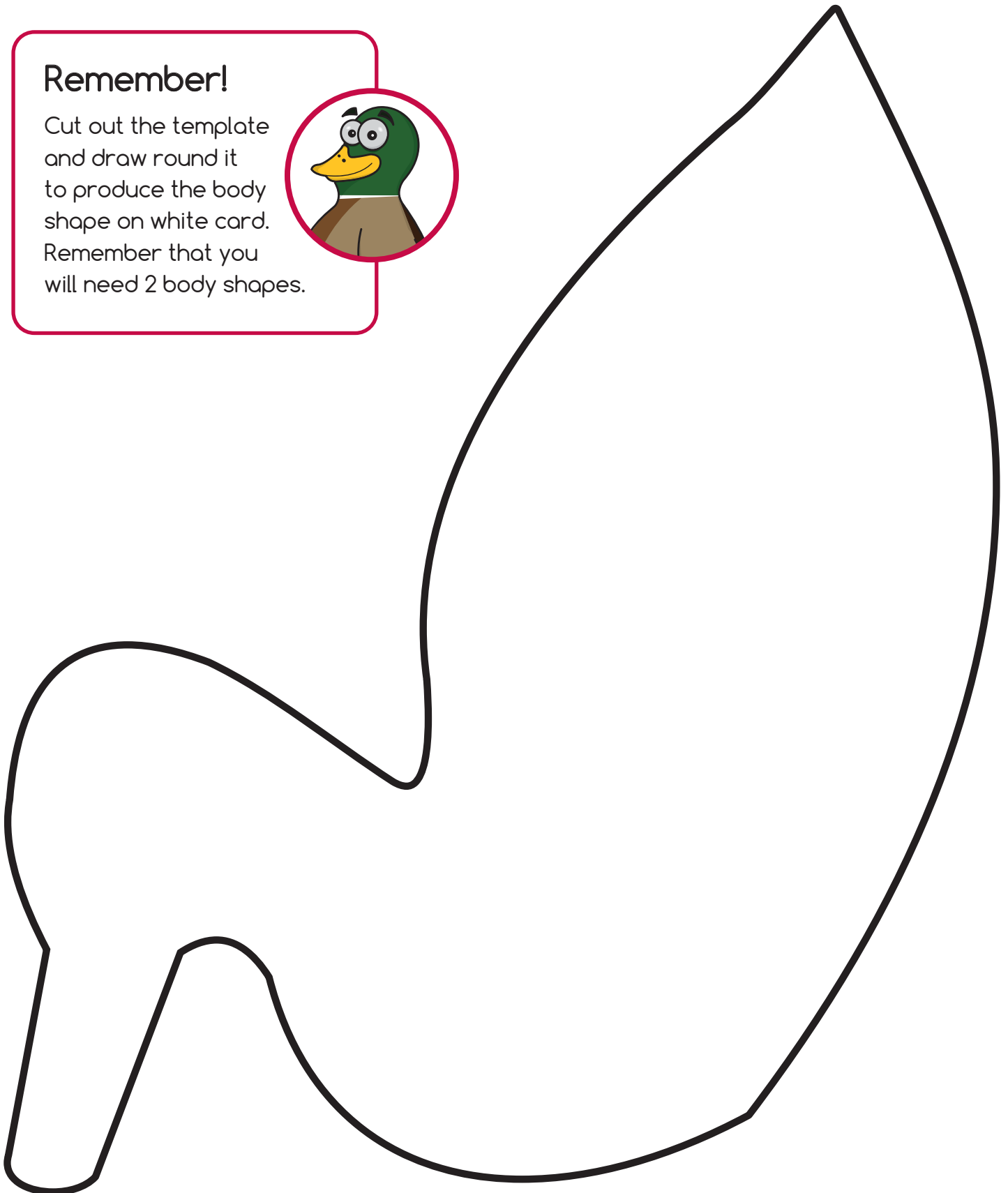
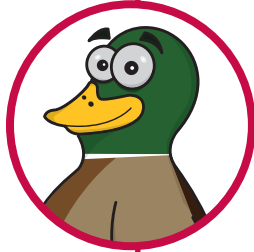

Duck Headpiece

Fun things to do: page 4 of 4

Remember!

Cut out the template and draw round it to produce the wing shape on white card. Remember that you will need 2 wing shapes.

